

Sheraton Zagreb Hotel

Kneza Borne, 2
 10000 Zagreb Croatia
 Tel. (385) (1) 4599 104
 Fax (385) (1) 4553035
 sheraton.zagreb@sheraton.com
 sheraton.com/zagreb

GROUND FLOOR

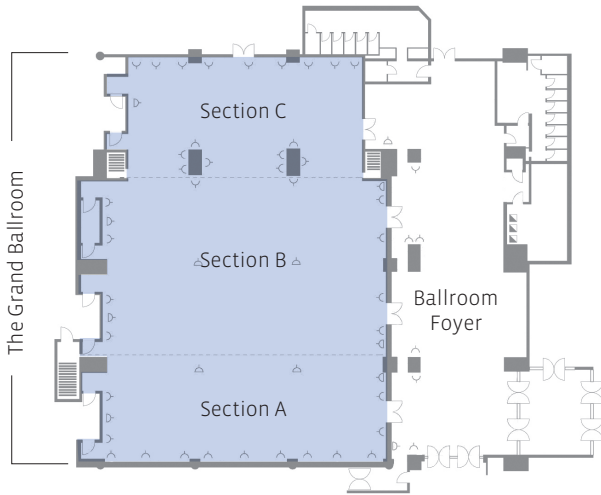

1ST FLOOR



Room Dimensions & Seating Capacity

Function rooms	daylight	sq.m.	ceiling h.m.	Theatre	Classroom	Banquet	Cocktail
The Grand Ballroom	no	617	4.70	600	250	450	800
Section A	no	170	4.70	130	70	90	100
Section B	no	292	4.70	300	150	300	200
Section C	no	150	3.50	90	60	70	80
Split	yes	16	2.60	10	8	10	8
Dubrovnik	yes	34	2.60	20	15	20	15
Opatija	yes	31	2.60	20	15	20	15
Pula	yes	37	2.60	25	18	25	20
Zagreb	yes	51	2.60	-	25	25	-
Split / Dubrovnik	yes	50	2.60	40	25	30	25
Opatija / Pula	yes	68	2.60	65	40	40	50
Berlin	yes	18	2.60	10	8	10	8
Paris	yes	22	2.60	10	8	10	8
Madrid	yes	34	2.60	20	15	16	15
London	no	40	2.60	25	15	16	20
Milano	no	30	2.60	20	15	10	10
Kralj Tomislav	yes	150	3.00	100	60	80	10

Sheraton Zagreb Hotel

Zagreb, Croatia

The Grand Ballroom

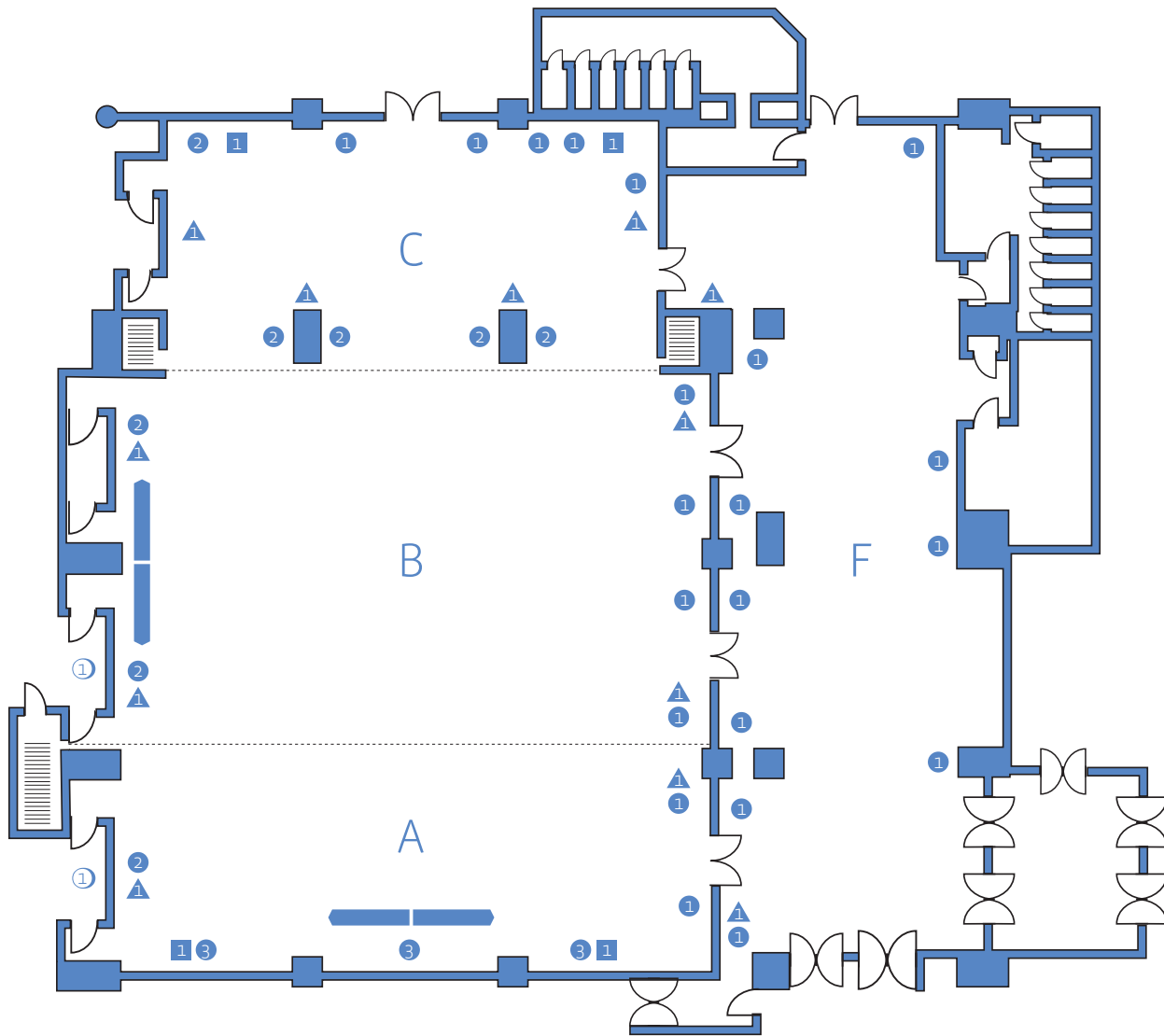

total area 617 m²

door h/w 1.7 x 2.0 m²

height 3 - 4.5 m

ground floor

- Power point 16A / 220v
- Power point (magic) 63A / 380v
- ▲ Telephone point
- Television socket
- ▭ Projection screen

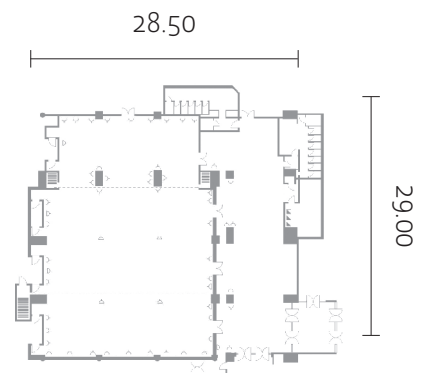

Sheraton Zagreb Hotel

Zagreb, Croatia

Milano

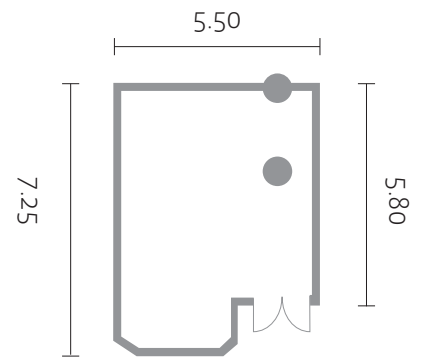
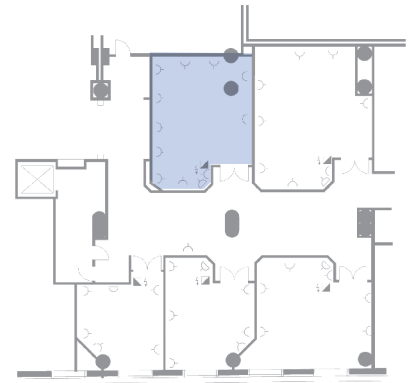
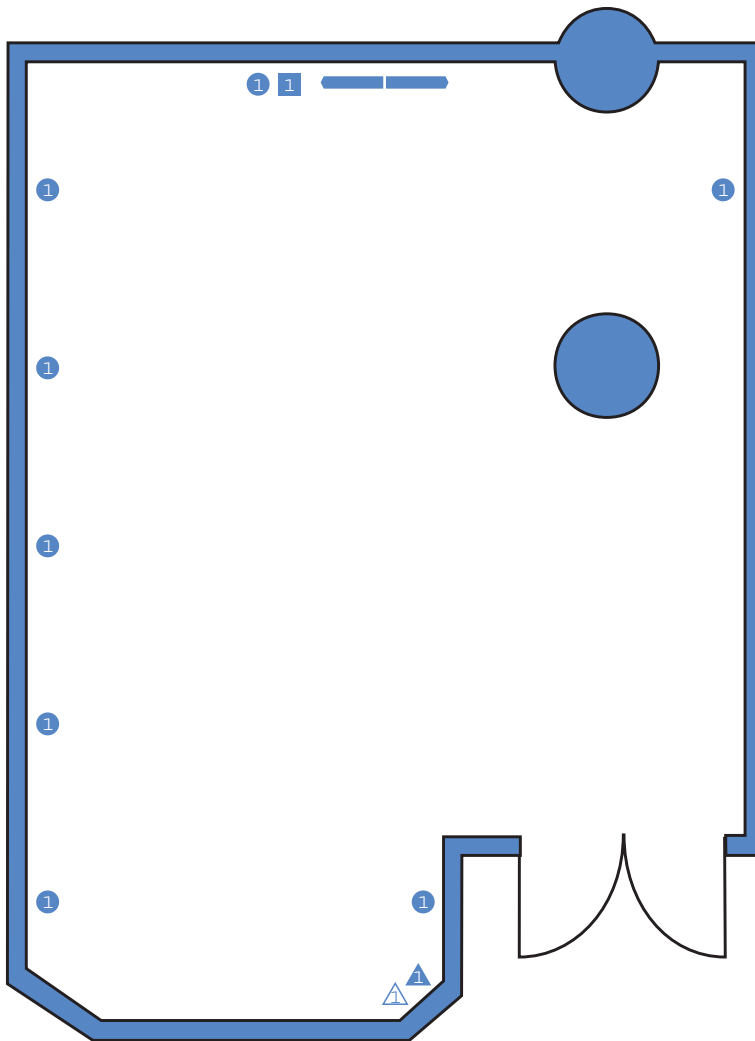

total area 30 m²

door h/w 1.7 x 2.0 m²
height 2.40 m

1st floor

- Power point 16A / 220v
- ▲ Telephone point
- Television socket
- △ Internet
- ▣ Projection screen

Sheraton Zagreb Hotel

Zagreb, Croatia

London

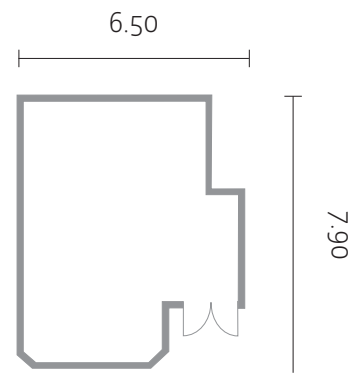
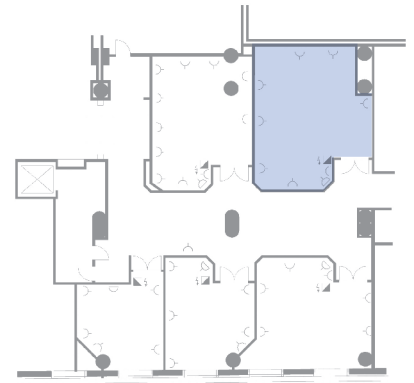
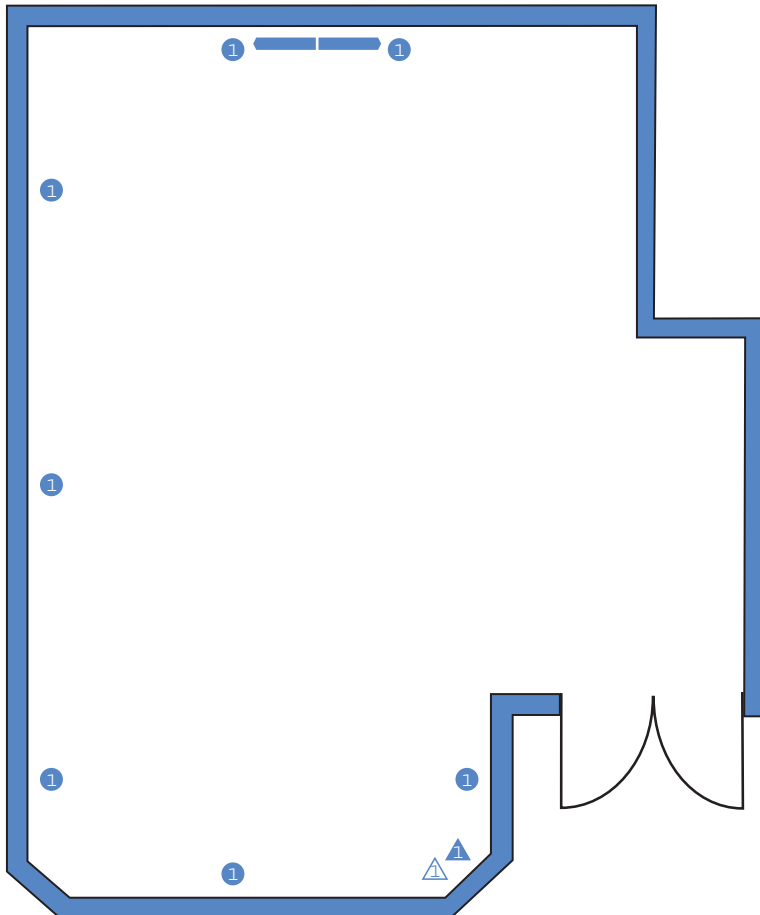

total area 40 m²

door h/w 1.7 x 2.0 m²
 height 2.40 m
 1st floor

- Power point 16A / 220v
- ▲ Telephone point
- △ Internet
- ▬ Projection screen

Sheraton Zagreb Hotel

Zagreb, Croatia

Berlin

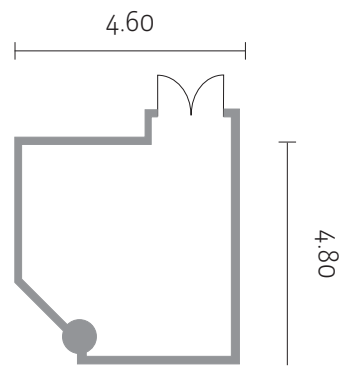
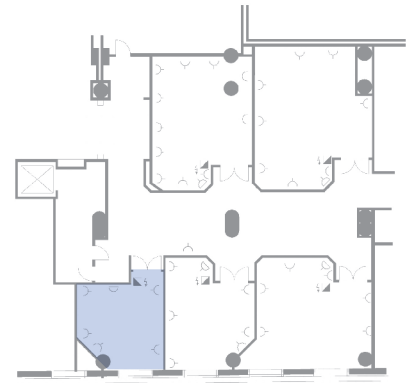
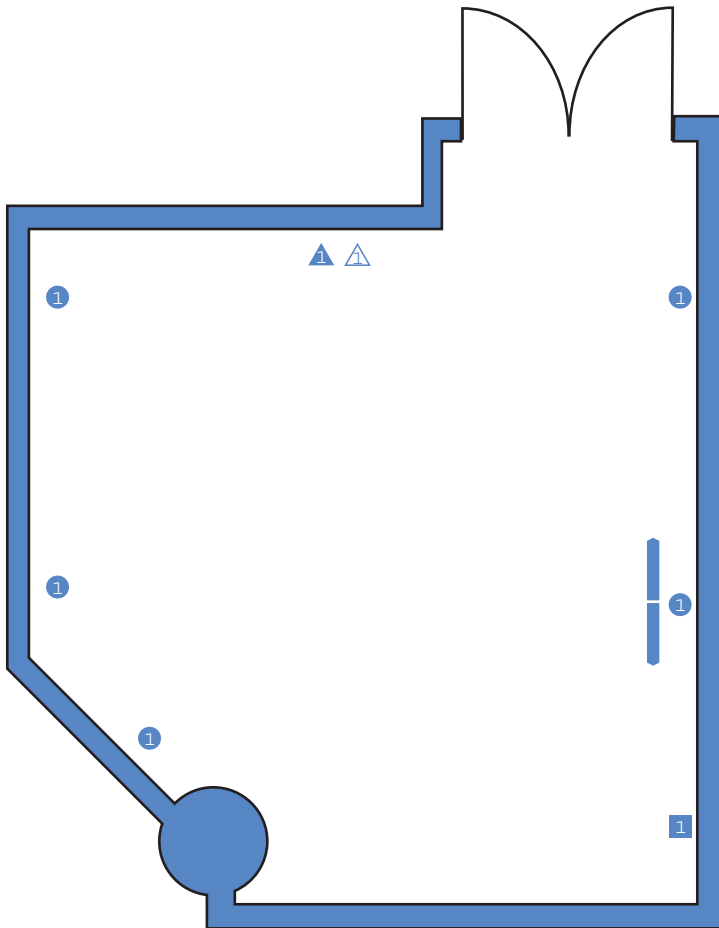

total area 18 m²

door h/w 1.4 x 2.0 m²
 height 2.40 m
 1st floor

- Power point 16A / 220v
- ▲ Telephone point
- Television socket
- △ Internet
- ▣ Projection screen

Sheraton Zagreb Hotel

Zagreb, Croatia

Paris

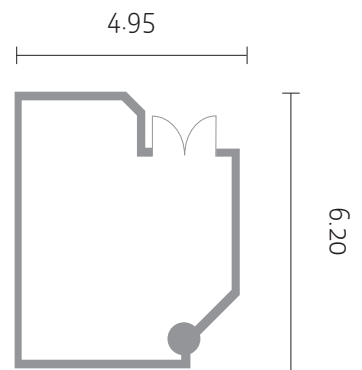
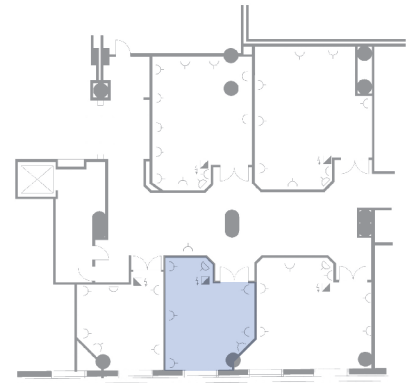
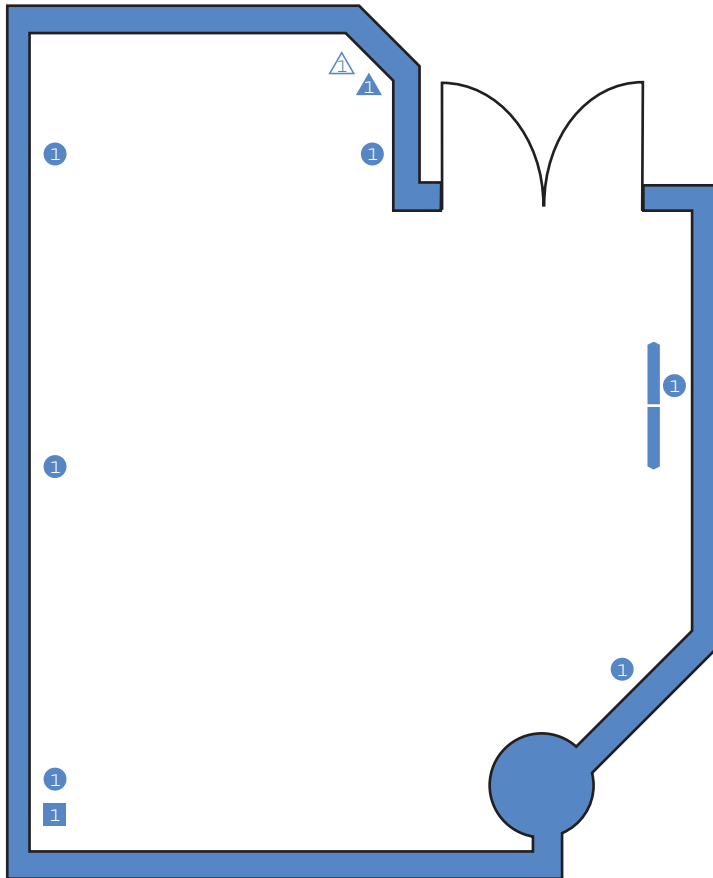

total area 22 m²

door h/w 1.7 x 2.0 m²
 height 2.40 m
 1st floor

- Power point 16A / 220v
- ▲ Telephone point
- Television socket
- △ Internet
- ▣ Projection screen

Sheraton Zagreb Hotel

Zagreb, Croatia

Madrid

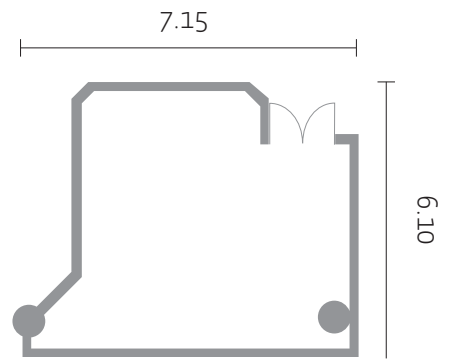
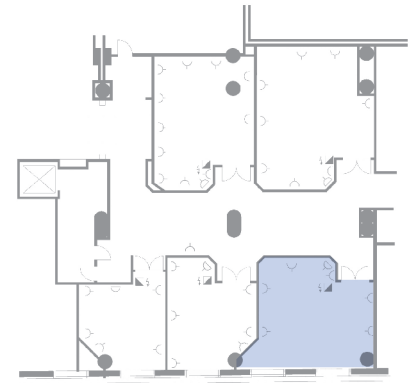
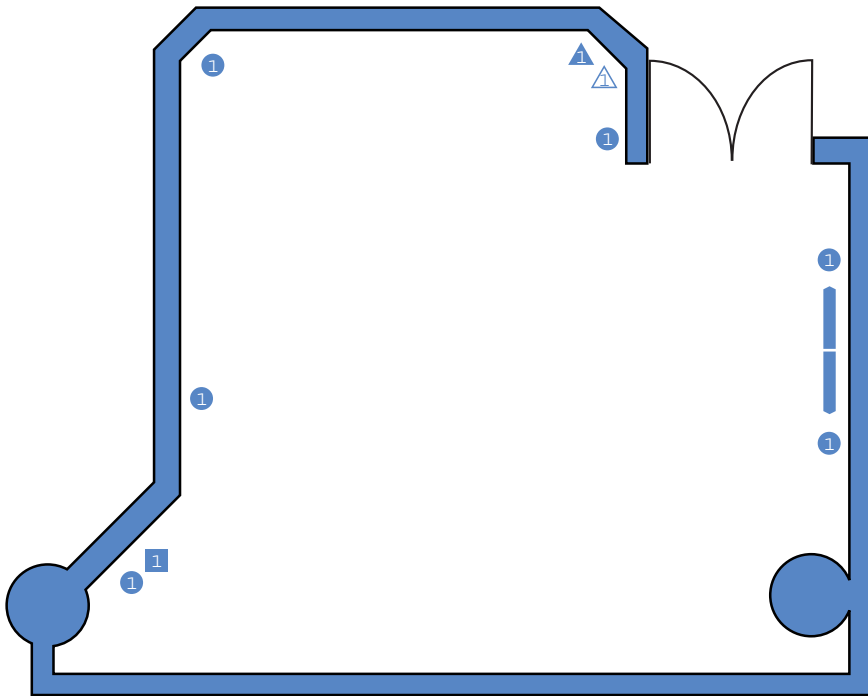

total area 34 m²

door h/w 1.7 x 2.0 m²
 height 2.40 m
 1st floor

- Power point 16A / 220v
- ▲ Telephone point
- Television socket
- △ Internet
- ▭ Projection screen

Sheraton Zagreb Hotel

Zagreb, Croatia

Split

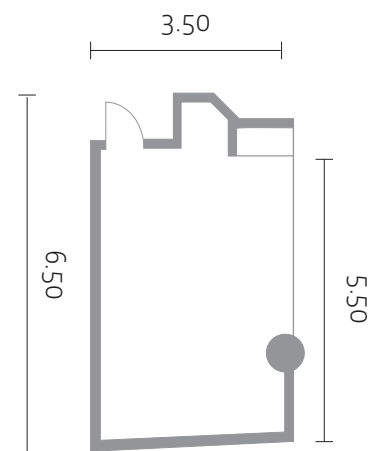
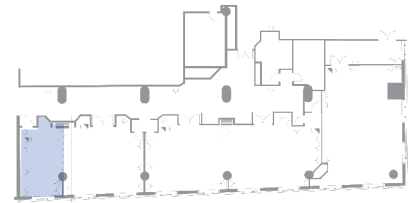
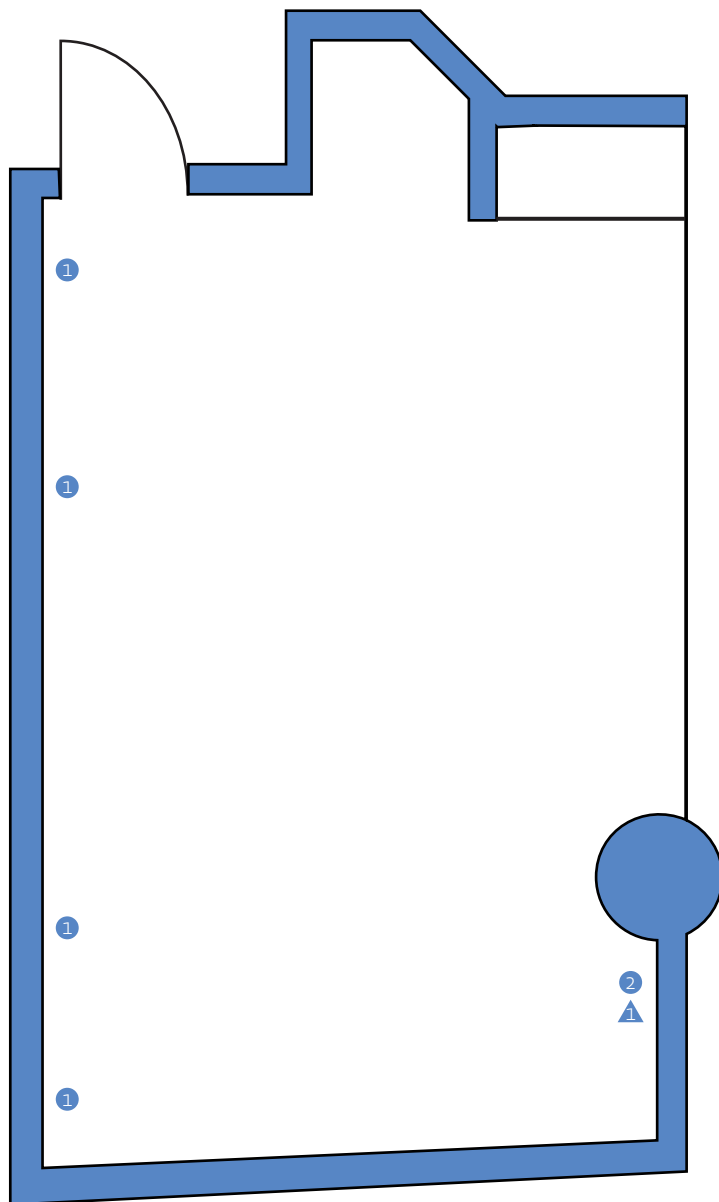

total area 16 m²
door h/w 0.8 x 2.0 m²
height 2.40 m
1st floor

- Power point 16A / 220v
- ▲ Telephone point

Sheraton Zagreb Hotel

Zagreb, Croatia

Dubrovnik

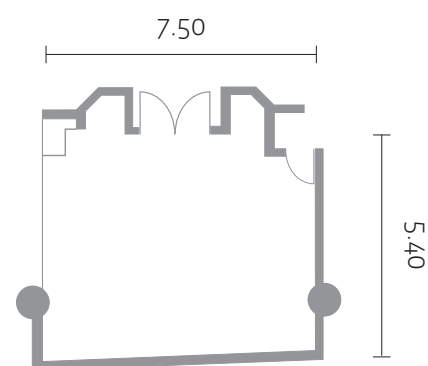
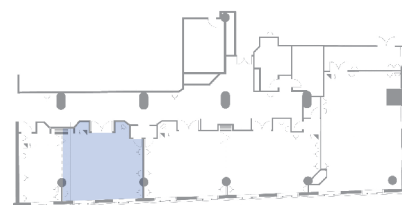
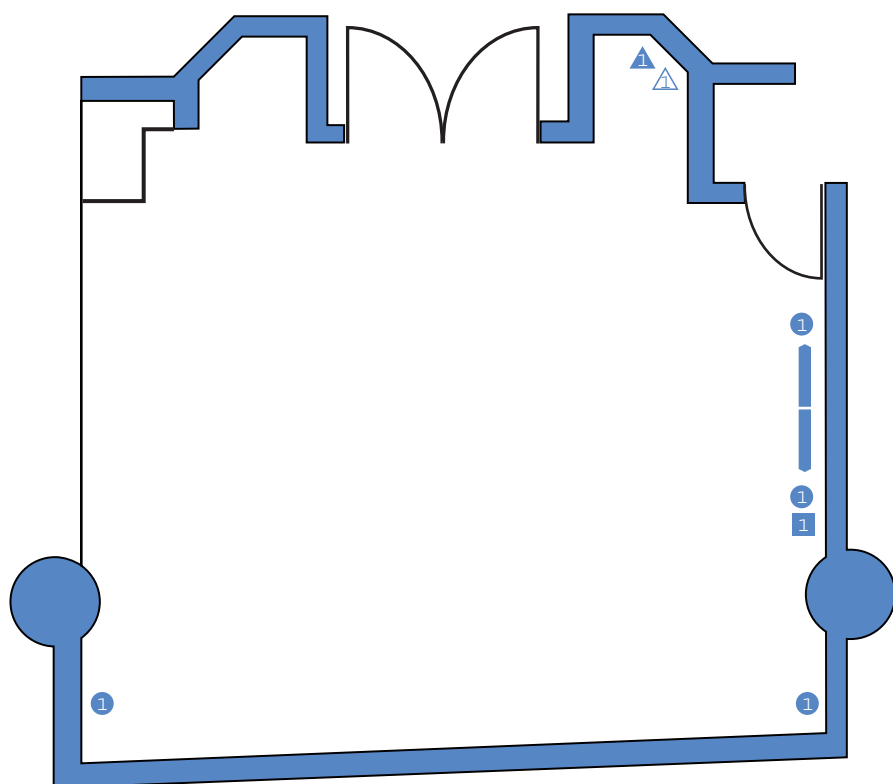

total area 34 m²

door h/w 1.5 x 2.0 m²
 height 2.40 m
 1st floor

- Power point 16A / 220v
- ▲ Telephone point
- Television socket
- △ Internet
- ▣ Projection screen

Sheraton Zagreb Hotel

Zagreb, Croatia

Opatija

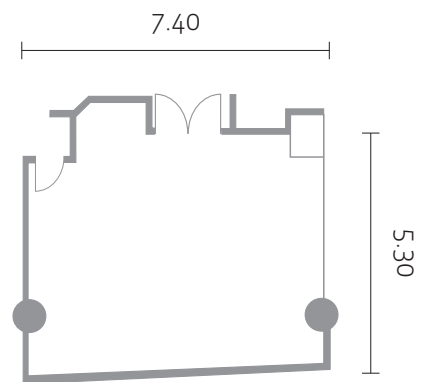
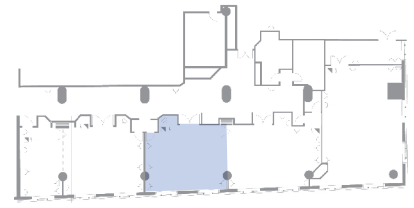
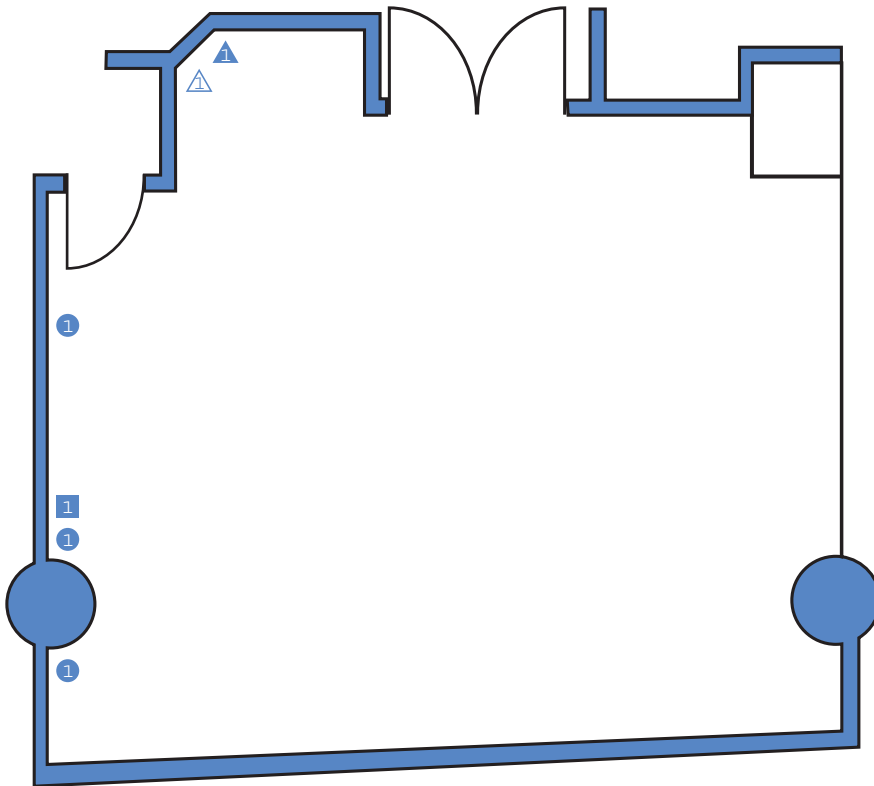

total area 31 m²

door h/w 1.6 x 2.0 m²
height 2.40 m
1st floor

- Power point 16A / 220v
- ▲ Telephone point
- Television socket
- △ Internet

Sheraton Zagreb Hotel

Zagreb, Croatia

Pula

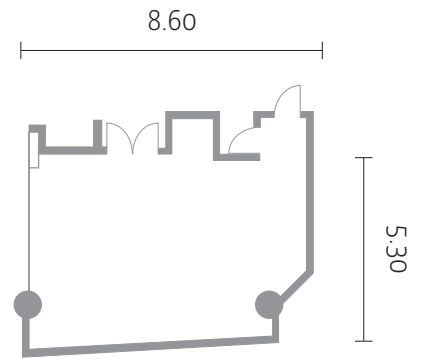
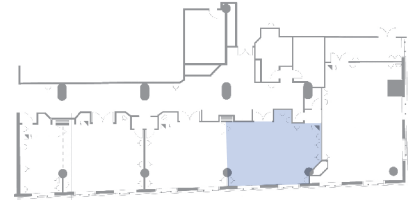
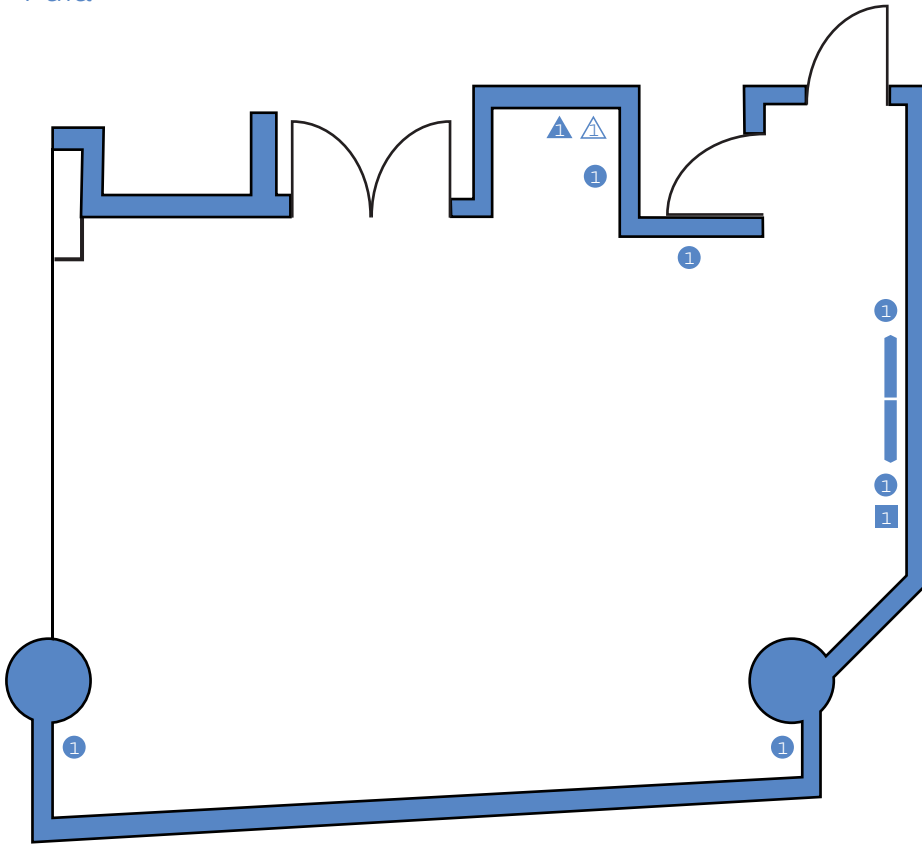

total area 37 m²

door h/w 1.6 x 2.0 m²
height 2.40 m
1st floor

- Power point 16A / 220v
- ▲ Telephone point
- Television socket
- △ Internet
- ▣ Projection screen

Sheraton Zagreb Hotel

Zagreb, Croatia

Zagreb

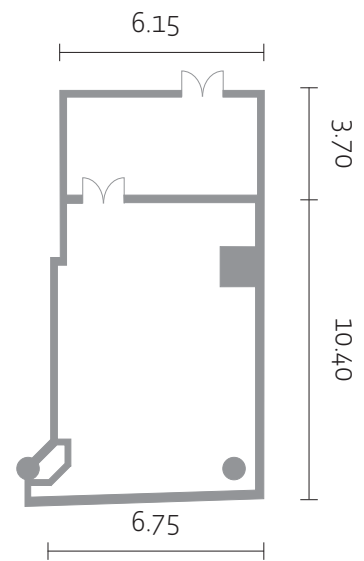
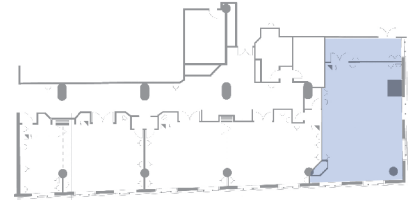
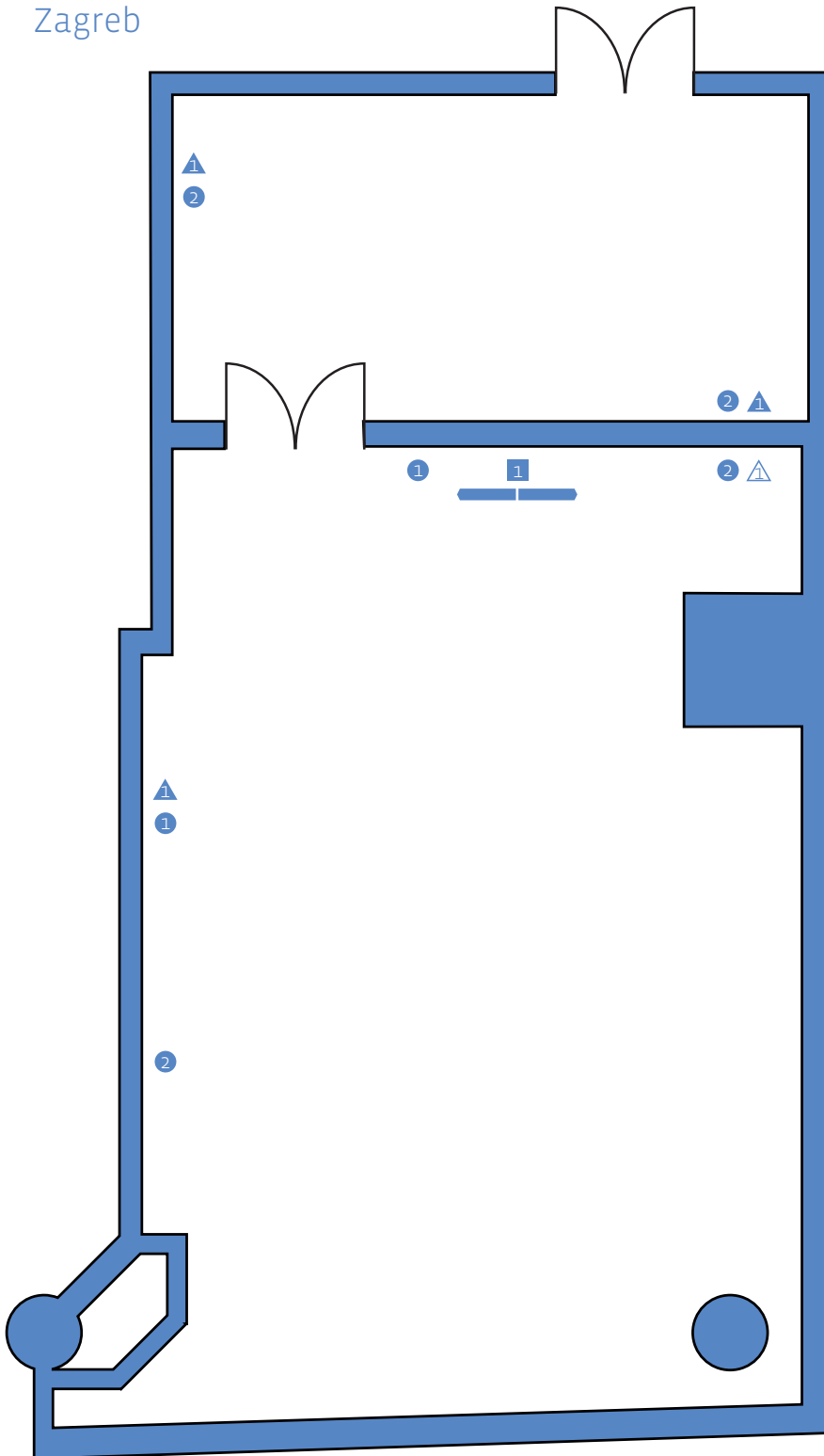

total area 51 m²

door h/w 1.6 x 2.0 m²

height 2.40 m

1st floor

- Power point 16A / 220v
- ▲ Telephone point
- Television socket
- △ Internet
- ▬ Projection screen